



User's manual

FLIR CM83

600 A True RMS Power Clamp Meter





User's manual FLIR CM83

Table of contents

1	Disclaimers	1
	1.1 Copyright.....	1
	1.2 Quality assurance	1
	1.3 Documentation updates.....	1
	1.4 Disposal of electronic waste.....	1
2	Safety information	2
	2.1 FCC Compliance	4
	2.2 Industry Canada compliance.....	5
3	Introduction	7
	3.1 Key features.....	7
4	Description	8
	4.1 Meter parts.....	8
	4.2 Function switch	9
	4.3 Function buttons.....	10
	4.4 Display icons and indicators	11
	4.4.1 Out-of-range warning	13
5	Operation	14
	5.1 Powering the meter	14
	5.1.1 Auto power off.....	14
	5.2 Auto/Manual select mode	14
	5.3 Auto/Manual range mode	15
	5.4 Hold mode	15
	5.4.1 Smart hold.....	15
	5.5 Silent mode	15
	5.6 Voltage and current measurements.....	16
	5.6.1 Basic voltage measurements.....	16
	5.6.2 Basic current measurements	16
	5.6.3 Extended functionality	17
	5.7 Non-contact voltage detector	21
	5.8 Power measurements	21
	5.8.1 Single-phase power measurements.....	21
	5.8.2 Three-phase power measurements	22
	5.8.3 Phase rotation.....	25
	5.9 Resistance measurements	27

Table of contents

5.10	Capacitance measurements	27
5.11	Continuity test	28
5.12	Diode test	29
5.13	Streaming measurement data using Bluetooth	30
	5.13.1 General	30
	5.13.2 Procedure	30
6	Maintenance.....	31
6.1	Cleaning and storage.....	31
6.2	Battery replacement	31
	6.2.1 Disposal of electronic waste	31
7	Technical specifications	32
7.1	General specifications	32
7.2	Electrical specifications	33
8	Technical support for external meters	39
9	Warranties	40
9.1	FLIR Global Limited Lifetime Warranty	40
9.2	FLIR Test and Measurement Limited 2 Year Warranty	41

1 Disclaimers

1.1 Copyright

© 2016, FLIR Systems, Inc. All rights reserved worldwide. No parts of the software including source code may be reproduced, transmitted, transcribed or translated into any language or computer language in any form or by any means, electronic, magnetic, optical, manual or otherwise, without the prior written permission of FLIR Systems.

The documentation must not, in whole or part, be copied, photocopied, reproduced, translated or transmitted to any electronic medium or machine readable form without prior consent, in writing, from FLIR Systems.

Names and marks appearing on the products herein are either registered trademarks or trademarks of FLIR Systems and/or its subsidiaries. All other trademarks, trade names or company names referenced herein are used for identification only and are the property of their respective owners.

1.2 Quality assurance

The Quality Management System under which these products are developed and manufactured has been certified in accordance with the ISO 9001 standard.

FLIR Systems is committed to a policy of continuous development; therefore we reserve the right to make changes and improvements on any of the products without prior notice.

1.3 Documentation updates

Our manuals are updated several times per year, and we also issue product-critical notifications of changes on a regular basis.

To access the latest manuals and notifications, go to the Download tab at:

<http://support.flir.com>

It only takes a few minutes to register online. In the download area you will also find the latest releases of manuals for our other products, as well as manuals for our historical and obsolete products.

1.4 Disposal of electronic waste



As with most electronic products, this equipment must be disposed of in an environmentally friendly way, and in accordance with existing regulations for electronic waste.

Please contact your FLIR Systems representative for more details.

2 Safety information



NOTE

Before operating the device, you must read, understand, and follow all instructions, dangers, warnings, cautions, and notes.

Note FLIR Systems reserves the right to discontinue models, parts or accessories, and other items, or to change specifications at any time without prior notice.



NOTE

Remove the batteries if the device is not used for an extended period of time.



WARNING

Do not operate the device if you do not have the correct knowledge. Formal qualifications and/or national legislation for the electrical inspections can apply. Incorrect operation of the device can cause damage, shock, injury or death to persons.



WARNING

Do not start the measuring procedure before you have set the function switch to the correct position. This can cause damage to the instrument and can cause injury to persons.



WARNING

Do not change to current or resistance when you measure the voltage. This can cause damage to the instrument and can cause injury to persons.



WARNING

Do not measure the current on a circuit when the voltage increases to more than 1000 V. This can cause damage to the instrument and can cause injury to persons.

2 Safety information



WARNING

You must disconnect the test leads from the circuit that you did a test on before you change the range. If you do not do this, damage to the instrument and injury to persons can occur.



WARNING

Do not replace the batteries before you remove the test leads. This can cause damage to the instrument and can cause injury to persons.



WARNING

Do not use the device if the test leads and/or the device show signs of damage. Injury to persons can occur.



WARNING

Be careful when you do the measurements if the voltages are more than 25 VAC rms or 35 VDC. There is a risk of shock from these voltages. Injury to persons can occur.



WARNING

Do not do diode, resistance, or continuity tests before you remove the power from the capacitors and the other devices (when you do a test during a measurement). Injury to persons can occur.



WARNING

Do not use the device as a tool to identify live terminals. You must use the correct tools. Injury to persons can occur if you do not use the correct tools.

2 Safety information



WARNING

Do not touch expired or damaged batteries without gloves. Injury to persons can occur.



WARNING

Do not cause a short-circuit of the batteries. This can cause damage to the instrument and can cause injury to persons.



WARNING

Do not put the batteries into a fire. Injury to persons can occur.



CAUTION

Do not use the device for a procedure that it is not made for. This can cause damage to the protection.



This symbol, adjacent to another symbol or terminal, indicates that the user must refer to the manual for further information.



This symbol, adjacent to a terminal, indicates that, under normal use, hazardous voltages may be present.



Double insulation.



UL listing is not an indication or a verification of the accuracy of the meter

2.1 FCC Compliance

This device complies with part 15 of the FCC Rules. Operation is subject to the following two conditions:

1. This device may not cause harmful interference.

2 Safety information

2. This device must accept any interference received, including interference that may cause undesired operation.

This equipment has been tested and found to comply with the limits for a Class B digital device, pursuant to part 15 of the FCC Rules. These limits are designed to provide reasonable protection against harmful interference in a residential installation. This equipment generates, uses, and can radiate radio frequency energy and, if not installed and used in accordance with the instructions, may cause harmful interference to radio communications. However, there is no guarantee that interference will not occur in a particular installation. If this equipment does cause harmful interference to radio or television reception, which can be determined by turning the equipment off and on, the user is encouraged to try to correct the interference by one or more of the following measures:

- Reorient or relocate the receiving antenna.
- Increase the separation between the equipment and receiver.
- Connect the equipment into an outlet on a circuit different from that to which the receiver is connected.
- Consult the dealer or an experienced radio/TV technician for help.



CAUTION

Exposure to Radio Frequency Radiation.

To comply with FCC/IC RF exposure compliance requirements, a separation distance of at least 20 cm must be maintained between the antenna of this device and all persons. This device must not be co-located or operating in conjunction with any other antenna or transmitter.



WARNING

Changes or modifications not expressly approved by the party responsible for compliance could void the user's authority to operate the equipment.

2.2 Industry Canada compliance

This device complies with Industry Canada licence-exempt RSS standard(s). Operation is subject to the following two conditions: (1) this device may not cause interference, and (2) this device must accept any interference, including interference that may cause undesired operation of the device.

2 Safety information



CAUTION

Exposure to Radio Frequency Radiation.

To comply with RSS 102 RF exposure compliance requirements, for mobile configurations, a separation distance of at least 20 cm must be maintained between the antenna of this device and all persons. This device must not be co-located or operating in conjunction with any other antenna or transmitter.

3 Introduction

Thank you for choosing a FLIR CM83 clamp meter.

This device is shipped fully tested and calibrated and, with proper use, will provide years of reliable service.

3.1 Key features

- 10 000-count digital display.
- Large-scale display.
- Analog bar graph.
- True RMS reading in AC and AC+DC mode.
- Work light.
- Auto AC/DC 600 A capability and selection.
- Auto AC/DC 1000 V capability and selection.
- Auto resistance/continuity/diode selection.
- Power and power factor measurement.
- Total harmonic distortion and 1 to 25 harmonics.
- Phase rotation Indication.
- 100 k Ω resistance capability.
- Non-contact voltage detector.
- Frequency measurement.
- Capacitance capability.
- Smart data hold.
- Peak hold.
- In-rush current.
- DCA zero key.
- Minimum/maximum and average hold.
- VFD mode – Low-pass filter.
- Auto power off.
- Jaw opening 37 mm (1.45") for conductors up to 1500 MCM.
- 1.2 m (4') drop-proof.
- Convenient battery cover.
- Safety Category Rating: CAT IV-600V, CAT III-1000V.

4 Description

4.1 Meter parts

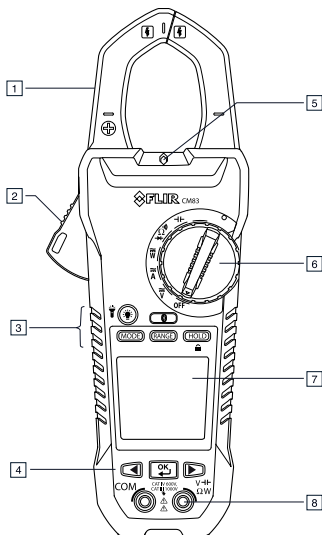

Figure 4.1 Front view

1. Clamp jaw.
2. Jaw opening trigger.
3. Function buttons, see section 4.3 *Function buttons*, page 10.
4. Navigation buttons.
5. Non-contact voltage detector light
6. Function switch, see section 4.2 *Function switch*, page 9.
7. LCD display.
8. Probe terminals.

4 Description

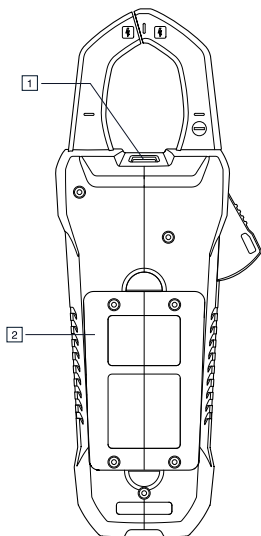







Figure 4.2 Rear view

1. Work light.
2. Battery compartment.





4.2 Function switch

	The meter can measure capacitance through the probe inputs.
	The meter can measure resistance, continuity, or diode polarity through the probe inputs. The type of measurement is selected by the MODE button.
	The meter can measure power through the probe inputs and the clamp jaws.
	The meter can measure current through the clamp jaws.

4 Description

	The meter can measure voltage through the probe inputs.
OFF	The meter is in full power-saving mode.

4.3 Function buttons

	<ul style="list-style-type: none">Use the button to select Auto select or Manual select mode, see section 5.2 <i>Auto/Manual select mode</i>, page 14.In Manual select mode, press the button to select the operating mode.
	<ul style="list-style-type: none">Use the button to select Auto range or Manual range mode, see section 5.3 <i>Auto/Manual range mode</i>, page 15.In Manual range mode, press the button to change the range (scale).
	<p>Press the button to toggle between Normal and Hold modes, see section 5.4 <i>Hold mode</i>, page 15.</p> <p>Holding the button down for 2 seconds enables/disables the key lock mode.</p> <p>In Hold mode, the meter will beep continuously and the display will flash if the measured signal is larger than the display reading (for the V.A.W. function).</p>
	<ul style="list-style-type: none">Press the button to enable/disable the display backlight.Press and hold the button for 2 seconds to enable/disable the work light.
	Press the button to enable/disable METERLiNK® (Bluetooth) communication, see section 5.13 <i>Streaming measurement data using Bluetooth</i> , page 30.

4 Description

4.4 Display icons and indicators

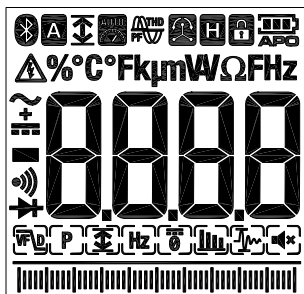





























Figure 4.3 Display

	Indicates that METERLiNK® (Bluetooth) communication is active, see section 5.2 <i>Auto/Manual select mode</i> , page 14.
	Indicates that the meter is in Auto select mode.
	Indicates that the meter is displaying maximum reading values.
	Indicates that the meter is displaying minimum reading values.
	Indicates that the meter is displaying the average reading.
	Indicates that the meter is displaying peak maximum values.
	Indicates that the meter is displaying peak minimum values.
	Indicates that the meter is in Auto range mode.
	Indicates that the meter is in Power factor mode.
	Indicates that the meter displays the total harmonic distortion.

4 Description

	Indicates that the meter is in Phase rotation mode.
	Indicates that the meter is in Hold mode.
	Indicates the battery voltage status.
APO	Indicates that the auto power off function is enabled.
	Indicates that the measured voltage is greater than 30 V DC or AC RMS.
	Indicates that the meter is measuring AC current or voltage.
	Indicates that the meter is measuring DC current or voltage.
	Indicates that the meter is measuring AC+DC current or voltage.
	Indicates that the continuity function is active.
	Indicates that the diode test function is active.
	VFD mode icon.
	Peak mode icon.
	Min/Max/Avg mode icon.
	DC Zero mode icon.
	Harmonic Distortion icon.
	In-rush current mode icon.
	Frequency mode icon.
	Silent mode icon.
	Lock mode icon.

4 Description

4.4.1 *Out-of-range warning*

If the input is out-of-range, *OL* is displayed.

5 Operation



NOTE

Before operating the device, you must read, understand, and follow all instructions, dangers, warnings, cautions, and notes.



NOTE

When the meter is not in use, the function switch should be set to the **OFF** position.



NOTE

When connecting the probe leads to the device under test, connect the negative lead before connecting the positive lead. When removing the probe leads, remove the positive lead before removing the negative lead.

5.1 Powering the meter

1. Set the function switch to any position to switch on the meter.
2. If the battery indicator  shows that the battery voltage is low or if the meter does not power on, replace the battery. See section 6.2 *Battery replacement*, page 31.

5.1.1 Auto power off

The meter enters sleep mode after 30 minutes of inactivity. The meter beeps three times 9 seconds before powering off. Press any button or turn the function switch to prevent the meter from powering off. The auto power off time-out is then reset.





To disable auto power off (APO); press the MODE button while turning meter on the meter.

5.2 Auto/Manual select mode

In Auto select mode, the meter attempts to automatically select the proper operating mode (e.g., AC or DC measurement) based on the input signal. In Manual select mode, the desired operating mode is selected manually.

5 Operation





Auto select mode is the default mode of operation. When a new function is selected with the function switch, the starting mode is Auto select and the  indicator is displayed.

- To enter Manual select mode, press the  button. To manually select the operating mode, press the  button repeatedly.
- To enter Auto select mode, press and hold the  button until the  indicator is displayed.

5.3 Auto/Manual range mode



In Auto range mode, the meter automatically selects the most appropriate measurement scale. In Manual range mode, the desired range (scale) is set manually.

Auto range mode is the default mode of operation. When a new function is selected with the function switch, the starting mode is Auto range and the  indicator is displayed.

- To enter Manual range mode, press the  button. To change the range, press the  button repeatedly until the desired range is displayed.
- To enter Auto range mode, press and hold the  button until the  indicator is displayed.

5.4 Hold mode

In Hold mode, the display freezes the last reading and continues to display this value.

Press the  button to toggle between Normal and Hold modes. In Hold mode, the  indicator is displayed.

5.4.1 Smart hold

The meter will beep continuously and the display will flash if the measured signal is larger than the display reading (for the V.A.W. function).

5.5 Silent mode

In Silent mode, the alert beeper is disabled. Silent mode does not affect the continuity beeper.

5 Operation

1. Use the navigation buttons to select the Silent mode icon , see section 5.6.3.1 *Selecting the mode*, page 17.

5.6 Voltage and current measurements

5.6.1 Basic voltage measurements



NOTE

If the measured voltage is greater than 30 V DC or AC RMS, the  indicator is displayed.

1. Set the function switch to the \overline{V} position.
2. To manually select AC, DC, or AC+DC measurement, press the **MODE** button repeatedly. Refer to section 5.2 *Auto/Manual select mode*, page 14.
3. To manually select the measurement range (scale), press the **RANGE** button repeatedly. Refer to section 5.3 *Auto/Manual range mode*, page 15.
4. Insert the black probe lead into the negative COM terminal and the red probe lead into the positive V terminal.
5. Connect the probe leads in parallel to the part under test.
6. Read the voltage value on the display.

5.6.2 Basic current measurements



WARNING

Do not measure the current on a circuit when the voltage increases to more than 1000 V. This can cause damage to the instrument and can cause injury to persons.

When measuring current using the clamp jaws, only one conductor should be enclosed by the jaws—refer to Figure 5.1.

5 Operation

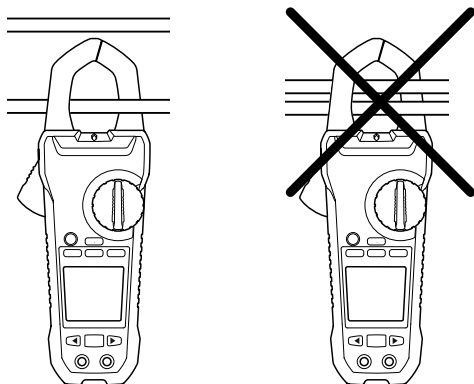

Figure 5.1 Correct and incorrect setup

1. Ensure that the probe leads are disconnected from the meter.
2. Set the function switch to the \bar{A} position.
3. To manually select AC, DC, or AC+DC measurement, press the **MODE** button repeatedly. Refer to section 5.2 *Auto/Manual select mode*, page 14.
4. To manually select the measurement range (scale), press the **RANGE** button repeatedly. Refer to section 5.3 *Auto/Manual range mode*, page 15.
5. Press the trigger to open the clamp jaws. Fully enclose one conductor—refer to Figure 5.1. For optimum results, center the conductor in the jaws.
6. Read the current value on the display.

5.6.3 Extended functionality

In addition to the basic voltage and current measurements, the meter can be set to different modes for extended functionality.

5.6.3.1 Selecting the mode

The mode icons applicable for the selected measurement type are displayed in the lower part of the display. When a mode is enabled, the icon is framed.

5 Operation



Figure 5.2 Mode icons (AC voltage measurements): Peak mode and Silent mode are enabled

The navigation buttons are used to select a mode icon and to enable/disable a mode:

- Use the and navigation buttons to navigate to a mode icon. The currently selected icon will flash.
- Press the button to enable/disable the selected (flashing) mode.

5.6.3.2 Peak mode

In Peak mode, the meter captures and displays the positive and negative peak values, and updates only when a higher/lower value is registered. Peak mode is available when measuring AC current or voltage in Manual select mode.

1. Use the navigation buttons to select and enable Peak mode.
2. Press the button to toggle between the display of Peak Max and Peak Min.
 - In Peak Max mode, the indicator is displayed.
 - In Peak Min mode, the indicator is displayed.
3. Press and hold the button for 2 seconds to disable Peak mode.

5.6.3.3 In-rush current mode

In In-rush current mode, the meter displays the highest current reading in the first 100 ms after the trigger point (current detection threshold, see Figure 5.3). The current detection threshold is 1.00 A for the 100.00 A range and 10.0 A for the 1000.0 A range. In-rush current mode is available when measuring AC current in Manual select mode.

1. Connect the meter to the unpowered circuit under test.
2. Set the function switch to the position.
3. Use the navigation buttons to select and enable In-rush current mode.
4. Turn on the power to the circuit under test

5 Operation



NOTE

If the in-rush current under testing may be more than 100 A AC, manually set the range to 600 A before activating the in-rush current mode, see section 5.3 *Auto/Manual range mode*, page 15.

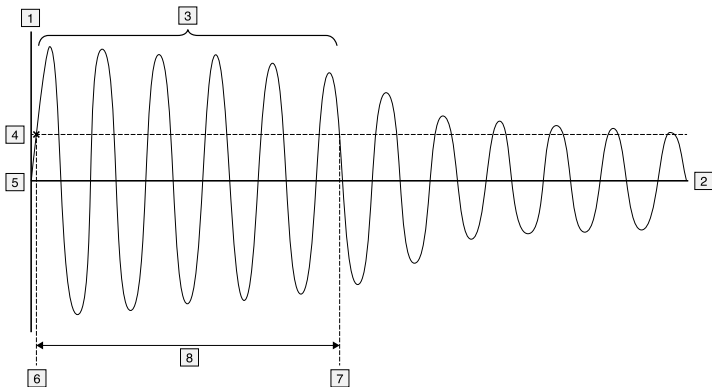



Figure 5.3 1: Current; 2: Time; 3: Measured In-rush Current; 4: Current Detection Threshold; 5: 0 A; 6: Start; 7: Stop; 8: 100 ms Sample Window (60 Hz).

5.6.3.4 DC Zero mode

The DC zero feature removes offset values and improves the accuracy for DC current measurements. DC Zero mode is available when measuring DC or AC +DC current in Manual select mode.

1. Ensure that there is no conductor in the clamp jaws.
2. Use the navigation buttons to select  and enable DC Zero mode.

5.6.3.5 Frequency mode

In Frequency mode, the meter measures and displays the frequency. Frequency mode is available when measuring AC current or voltage in Manual select mode.

5 Operation









NOTE

Do not switch to the Frequency mode until the meter is set up and actively measuring the voltage or current signal.

1. Use the navigation buttons to select  and enable Frequency mode.

5.6.3.6 Min/Max/Avg mode





In Min/Max/Avg mode, the meter captures and displays the minimum or maximum values and updates only when a higher/lower value is registered. The meter can also display the average of all values recorded from the beginning of Min/Max/Avg mode.

1. Use the navigation buttons to select  and enable Min/Max/Avg mode.
2. Press the  button repeatedly to cycle through the minimum, maximum, and average reading displays. The corresponding icons are displayed: , , or .
3. Press and hold the  button for 2 seconds to disable Min/Max/Avg mode.



5.6.3.7 Harmonic Distortion mode

In Harmonic Distortion mode, the meter displays the distortion percentage value for the first 25 harmonics as well as the total harmonic distortion. Harmonic Distortion mode is available when measuring AC current or voltage in Manual select mode.

The harmonic distortion is expressed as $H_n = (\text{RMS of an individual harmonic } n) / (\text{RMS of the fundamentals}) \times 100\%$.

1. Use the navigation buttons to select  and enable Harmonic Distortion mode.
2. While in Harmonic Distortion mode, use the  and  navigation buttons to navigate through the individual and total harmonic data. H01, H02, ..., Hn is displayed.
3. When the total harmonic distortion is displayed, the  indicator appears in the upper part of the display and 'thd' is shown in the main display.

5 Operation

- Press the  button to switch the display between Harmonic Order Indication mode and Percentage mode.
- Press and hold the  button for 2 seconds to disable Harmonic Distortion mode.

5.6.3.8 VFD mode – Low-pass filter

In VFD mode, high-frequency noise is eliminated from the voltage measurement by a low-pass filter. VFD mode is intended for measurements on variable-frequency drives (VFDs). VFD mode is available when measuring AC current or voltage in Manual select mode.

- Use the navigation buttons to select  and enable VFD mode.

5.7 Non-contact voltage detector



NOTE

Test on a known live circuit before testing on an unfamiliar circuit.

- Hold the clamp tips of the meter very close to the voltage source.
- If voltage is present, the non-contact voltage alert lamp (see section 4.1 *Meter parts*, page 8) illuminates a red color.



CAUTION

If the non-contact voltage alert lamp is not illuminated, voltage could still be present.

5.8 Power measurements

5.8.1 Single-phase power measurements

- Set the function switch to the  position.
- Insert the black probe lead into the negative COM terminal and the red probe lead into the positive W terminal.



5 Operation

3. Press the trigger to open the clamp jaws. Fully enclose one conductor—refer to Figure 5.1. For optimum results, center the conductor in the jaws.



NOTE

The + symbol on the jaw should be directed toward the power source.

4. Connect the probe leads in parallel to the part under test.
5. Read the active power value on the display.
 - If the value is displayed without a sign, the power is flowing from the power source to the load.
 - If the value is displayed with a minus sign (-), the power is flowing from the power load to the source.
6. To measure and display the power factor, press the **MODE** button repeatedly until the  indicator is displayed.
7. Read the power factor value on the display.
 - If the value is displayed without a sign, the phase of the current signal is lagging behind the voltage signal (inductive load).
 - If the value is displayed with a minus sign (-), the phase of the current signal is leading the voltage signal (capacitive load).
8. To return to active power measurements, press the **MODE** button repeatedly until neither the  nor the  indicator is displayed.

If an overload occurs, the following is displayed:

- *OL. V*: Voltage overload or both voltage and current overload.
- *OL. A*: Current overload.
- *OL. kW*: Active power overload.

5.8.2 Three-phase power measurements

5.8.2.1 Three-phase three-wire balanced/unbalanced

The power of a three-phase three-wire delta configuration is measured in two steps, in accordance with Figure 5.4. The total power is the sum of the two measurements: $W = W_1 + W_2$.

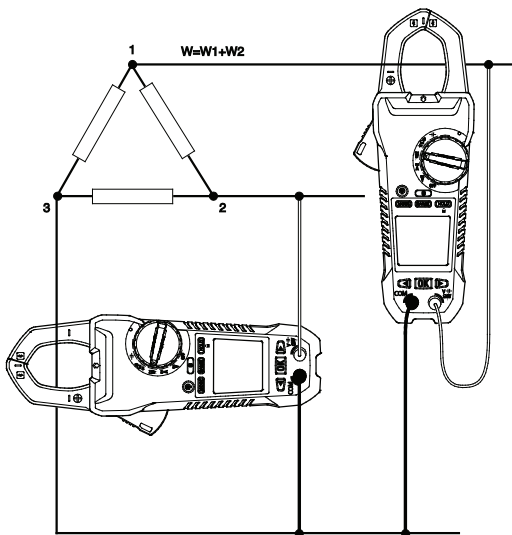



Figure 5.4 Three-phase three-wire measurement

1. Set the function switch to the \overline{W} position.
2. Ensure that the meter is set to active power measurement. If the \overline{PF} or the \overline{PF} indicator is displayed, press the **MODE** button repeatedly until none of these indicators are displayed.
3. Take two measurements of the active power, in accordance with Figure 5.4.
4. To measure and display the power factor, press the **MODE** button repeatedly until the \overline{PF} indicator is displayed.
5. Read the power factor value on the display.
 - If the value is displayed without a sign, the phase of the current signal is lagging behind the voltage signal (inductive load).
 - If the value is displayed with a minus sign (-), the phase of the current signal is leading the voltage signal (capacitive load).

5 Operation

- To return to active power measurements, press the **MODE** button repeatedly until neither the  nor the  indicator is displayed.

5.8.2.2 Three-phase four-wire balanced/unbalanced

The power of a three-phase four-wire configuration is measured in three steps, accordance with Figure 5.5. The total power is the sum of the three measurements: $W = W_1 + W_2 + W_3$.

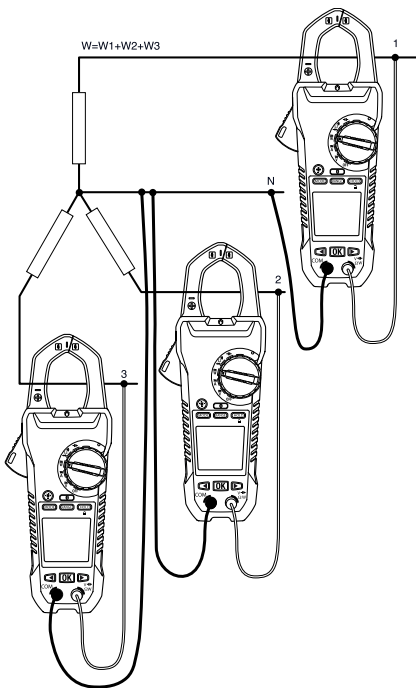



Figure 5.5 Three-phase four-wire measurement

5 Operation

1. Set the function switch to the \overline{W} position.
2. Ensure that the meter is set to active power measurement. If the \overline{PF} or the  indicator is displayed, press the **MODE** button repeatedly until none of these indicators are displayed.
3. Take three measurements of the active power, in accordance with Figure 5.5.
4. To measure and display the power factor, press the **MODE** button repeatedly until the \overline{PF} indicator is displayed.
5. Read the power factor value on the display.
 - If the value is displayed without a sign, the phase of the current signal is lagging behind the voltage signal (inductive load).
 - If the value is displayed with a minus sign (-), the phase of the current signal is leading the voltage signal (capacitive load).
6. To return to active power measurements, press the **MODE** button repeatedly until neither the \overline{PF} nor the  indicator is displayed.

5.8.3 Phase rotation

With the meter set to Phase rotation mode, it is possible to determine the phase rotation for a three-wire system.



NOTE

The system frequency must be stable.

5 Operation

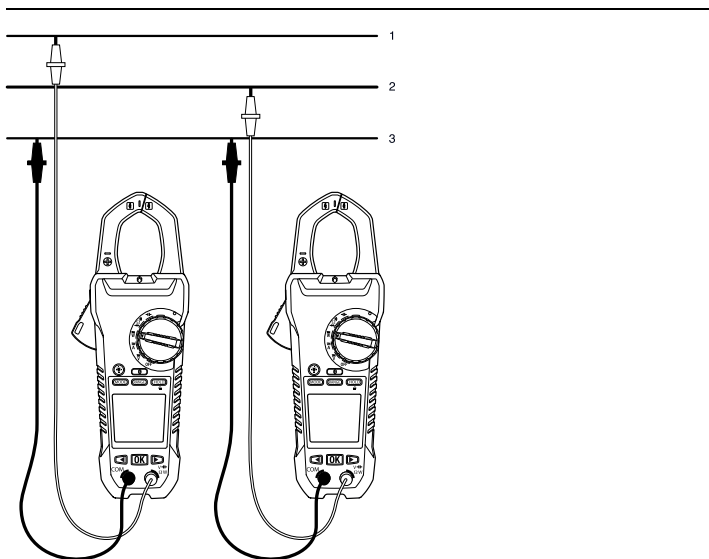



Figure 5.6 Phase rotation

1. Set the function switch to the \tilde{V} position.
2. Enter Phase rotation mode by pressing the **MODE** button repeatedly until the  indicator is displayed.
3. Connect the red test lead to the presumed phase line 1 and the black test lead to the presumed phase line 3.
4. One of the following results is displayed:
 - *OL V* flashes if the voltage is >1000 V.
 - *Lo V* flashes if the voltage is <30 V.
 - *outF* flashes if the frequency is >65 Hz or <45 Hz.
 - If normal, *L1* is displayed for about 3 seconds. Then *L2* is displayed and the meter beeps twice.
5. Move the red test lead to the presumed phase line 2 immediately, before "*L2*" extinguishes from the display.

5 Operation

6. One of the following results is displayed:
- *123* indicates clockwise or forward rotation, which means that the presumed phase line 1 is ahead of the presumed phase line 2.
 - *321* indicates counterclockwise or reversed rotation, which means that the presumed phase line 2 is ahead of the presumed phase line 1.
 - *- - -* means that the meter is unable to determine the results.
 - *Lo V* means that users possibly removed the test leads before completing the testing procedure. To repeat the test, press the OK button again.

5.9 Resistance measurements



WARNING

Do not do diode, resistance, or continuity tests before you remove the power from the capacitors and the other devices (when you do a test during a measurement). Injury to persons can occur.

1. Set the function switch to the Ω position.
2. Ensure that the meter is set to resistance measurement. If the $\bullet\))$ or the $\rightarrow+$ indicator is displayed, press the **MODE** button repeatedly until none of these indicators are displayed.
3. Insert the black probe lead into the negative COM terminal and the red probe lead into the positive Ω terminal.
4. Touch the tips of the probe across the circuit or component under test.
5. Read the resistance value on the display.

5.10 Capacitance measurements



WARNING

Do not take capacitance measurements before you have removed the power from the capacitor or other device or circuit during a test. Injury to persons can occur.

5 Operation



NOTE

To protect the internal components, if a capacitor that is being tested has a charge, the meter will first discharge the cap and show *diSC*. After a complete discharge the meter will conduct a normal test. *diSC* may also be displayed if the incorrect input is provided (e.g., measuring voltage while in capacitance mode).

1. Set the function switch to the $\text{--}\text{||}\text{--}$ position.
2. Insert the black probe lead into the negative COM terminal and the red probe lead into the positive $\text{--}\text{||}\text{--}$ terminal.
3. Touch the tips of the probe across the part under test.
4. Read the capacitance value on the display.



NOTE

For very large capacitance values, it may take several seconds for the measurement to settle and the final reading to stabilize.

5.11 Continuity test



WARNING

Do not do diode, resistance, or continuity tests before you remove the power from the capacitors and the other devices (when you do a test during a measurement). Injury to persons can occur.

1. Set the function switch to the $\text{---}\text{||}\text{---}$ position.
2. Insert the black probe lead into the negative COM terminal and the red probe lead into the positive Ω terminal.
3. Use the **MODE** button to select continuity measurement. The $\text{---}\text{||}\text{---}$ indicator will be displayed.
4. Touch the tips of the probe across the circuit or component under test.
5. If the resistance is less than 30 Ω , the meter will beep.

5 Operation

5.12 Diode test



WARNING

Do not do diode, resistance, or continuity tests before you remove the power from the capacitors and the other devices (when you do a test during a measurement). Injury to persons can occur.

The meter checks diodes using an alternating test signal sent through the diode in both directions. This allows the user to check the diode without having to reverse the polarity manually. The meter display will show $\pm 0.4\text{--}0.8\text{V}$ for a good diode, bAd for a shorted diode, and $O.L$ for an opened diode. See Figure 5.7.

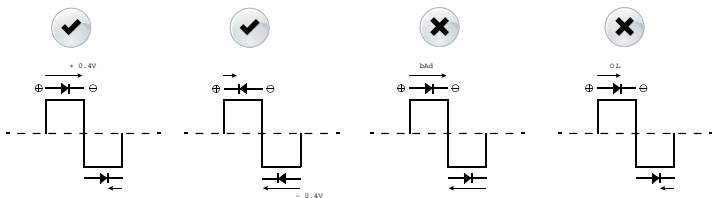

Figure 5.7 Diode testing

1. Set the function switch to the $\rightarrow\text{D}$ position.
2. Insert the black probe lead into the negative COM terminal and the red probe lead into the positive Ω terminal.
3. Use the **MODE** button to select the diode test function. The $\rightarrow\text{D}$ indicator will be displayed.
4. Touch the tips of the probe across the diode or semiconductor junction under test.
5. If the reading is between ± 0.40 and $+0.80$ V, the component is good; an bAd or $O.L$ display indicates a defective component.

5 Operation

5.13 Streaming measurement data using Bluetooth

5.13.1 General

Some IR cameras from FLIR Systems support Bluetooth communication, and to those cameras you can stream measurement data from the meter. The data is then merged into the result table in the IR image.

Streaming measurement data is a convenient way to add important information to an IR image. For example, when identifying an overheated cable connection, you may want to know the current in that cable.

The Bluetooth range is 10m (32ft) maximum.

5.13.2 Procedure

1. Pair the IR camera with the instrument. Refer to the camera manual for information on how to pair Bluetooth devices.
2. Turn on the camera.
3. Turn on the meter.
4. Press the  on the meter to enable Bluetooth.
5. Choose the variable that you want to use (voltage, current, resistance, etc.). Results from the meter will now automatically be displayed in the result table in the top left corner of the IR camera screen.

6 Maintenance

6.1 Cleaning and storage

Clean the meter with a damp cloth and mild detergent; do not use abrasives or solvents.

If the meter is not to be used for an extended period, remove the batteries and store them separately.

6.2 Battery replacement

1. To avoid electrical shock, disconnect the meter if connected to a circuit, remove the probe/thermocouple leads from the terminals, and set the function switch to the **OFF** position before attempting to replace the batteries.
2. Unscrew and remove the battery compartment cover.
3. Replace the six standard AAA batteries, observing correct polarity.
4. Secure the battery compartment cover.

6.2.1 Disposal of electronic waste



As with most electronic products, this equipment must be disposed of in an environmentally friendly way, and in accordance with existing regulations for electronic waste.

Please contact your FLIR Systems representative for more details.

7 Technical specifications



7.1 General specifications

Display count: 10 000 or 4000.

Measuring rate: 3 times per second.

Over-range indication: *OL* or *-OL*.

Auto power off: Approx. 30 minutes.

Low battery indicator:  is displayed. Replace the battery when the indicator  appears in the display.

Power requirement: 6 × 1.5 V AAA alkaline batteries.

Battery life: Approx. 50 hours with alkaline batteries (backlight, work light, and Bluetooth are off).

Environmental conditions: Indoor use.

Calibration: 1 year calibration cycle.

Operating temperatures:

- 0 to 10°C (32 to 50°F)(non-condensing)
- 10 to 30°C (50 to 86°F) (\leq 80% RH)
- 30 to 40°C (86 to 104°F) (\leq 75% RH)
- 40 to 50°C (104 to 122°F) (\leq 45%RH)

Storage temperature:

- -10 to 50°C (14 to 122°F).
- 0–80% RH (batteries not fitted).

Dimensions (H × W × L): 49 mm × 100 mm × 262 mm (1.9" × 3.9" × 10.3").

Weight: 0.59 kg (1.29 lb.), including batteries.

Bluetooth range: 10 m (32 ft.) maximum.

Temperature coefficient: $0.2 \times (\text{specified accuracy})/^{\circ}\text{C}$, $<18^{\circ}\text{C}$, $>28^{\circ}\text{C}$.

Over-voltage category: IEC 61010-1 CAT IV-600 V, CAT III-1000 V, IEC 61010-2-033.

7 Technical specifications

CAT	Application field
I	Circuits not connected to mains
II	Circuits directly connected to a low-voltage installation
III	Building installation
IV	Source of the low-voltage installation

Operating altitude: 2000 m (6562').

Jaw opening: 37 mm (1.45 in.).

Pollution degree: 2.

EMC: EN 61326-1.

Shock vibration: Random vibration per MIL-PRF-28800f Class 2 (5–55 Hz, 3g maximum).

7.2 Electrical specifications

Accuracy is \pm (% reading + number of digits (dgt)) at 23°C \pm 5°C (73.4°F \pm 9°F), <80% RH.

Table 7.1 Voltage (TRMS)

Function	Range	Accuracy (of reading)
DCV	99.99 V	\pm (0.7% + 2 dgt)
	999.9 V	
ACV	0.05–99.99 V	\pm (1.0% + 5 dgt)
	999.9 V	50–500 Hz
VFD ACV	0.05–99.99 V	50–60 Hz \pm (1% + 5 dgt)
	999.9 V	

1. DCV <1000 dgt, add 6 dgt to the accuracy. ACV <1000 dgt, add 3 dgt to the accuracy.

Overload protection: 1000 V_{rms}.

7 Technical specifications

Input impedance: $3.5 \text{ M}\Omega //, <100 \text{ pF}$.

AC conversion type: AC coupled, true RMS responding, calibrated to the RMS value of a sine wave input. Accuracies are given for sine waves at full scale and non-sine waves below half scale. For non-sine waves (50/60 Hz), add the following crest factor corrections:

- For a crest factor of 1.4–2.0, add 1.0% to the accuracy.
- For a crest factor of 2.0–2.5, add 2.5% to the accuracy.
- For a crest factor of 2.5–3.0, add 4.0% to the accuracy.

CF:

- 3 @ 460 V, 280 A.
- 2 @ 690 V, 420 A.

AC+DC V_{rms} accuracy: Same as ACV specification + DCV specification.

Table 7.2 Current (TRMS)

Function	Range	Accuracy
DCA	99.99 A	$\pm(2\% + 0.5 \text{ A})$
	599.9 A	$\pm(2\% + 5 \text{ dgt})^*$
ACA	0.10–99.99 A	50–60 Hz $\pm(2\% + 5 \text{ dgt})^*$
	599.9 A	>60–400 Hz $\pm(2.5\% + 5 \text{ dgt})^*$
VFD	0.10–99.99 A	50–60 Hz $\pm(2\% + 5 \text{ dgt})^*$
ACA	599.9 A	

* For measured values <1000 dgt, add 5 dgt to the accuracy.

Overload protection: $600 A_{\text{rms}}$.

Position error: $\pm 1\%$ of reading.

AC conversion type and additional accuracy is same as for the AC voltage.

AC+DC A_{rms} accuracy: Same as ACA specification + DCA specification. The DCA is affected by the temperature and the residual magnetism. Use the DCA zero function to compensate.

7 Technical specifications

Table 7.3 Peak hold: peak maximum/peak minimum (AC only, Non TRMS)

Function	Range	Accuracy
ACV	140.0 V	$\pm(3.0\% + 15 \text{ dgt})$
	1400 V	
ACA	140.0 A	$\pm(3.5\% + 15 \text{ dgt})$
	850 A	

Overload protection: 1000 V_{rms} , 600 A_{rms}

Peak Hold Response time: 200 μs

Accuracy defined for sine waves, ACV > 5 V_{rms} /ACA \geq 5 A_{rms} , frequency 50–400 Hz. Only suitable for repetitive events.

Table 7.4 Frequency

Function	Range	Accuracy
Frequency	20.00–99.99 Hz	$\pm(0.5\% + 3 \text{ dgt})$
	20.0–999.9 Hz	
	0.020–9.999 kHz	

Overload protection: 1000 V_{rms} , 600 A_{rms} .

Sensitivity:

- 10–100 V_{rms} for AC 100 V range.
- 10–100 A_{rms} for AC 100 A range (>400 Hz unspecified).
- 100–1000 V_{rms} for AC 1000 V range.
- 100–600 A_{rms} for AC 600 A range (>400 Hz unspecified).

The reading will be 0.0 for signals below 10.0 Hz.

Table 7.5 Total harmonic distortion

Function	Range	Accuracy
ACA/ACV	99.9%	$\pm(3.0\% + 10 \text{ dgt})$

7 Technical specifications

Table 7.6 Harmonic distortion measurement

Harmonic order	Range	Accuracy
H01–H12	99.9%	$\pm(5\% + 10 \text{ dgt})$
H13–H25		$\pm(10\% + 10 \text{ dgt})$

Overload protection: 1000 V_{rms} , 600 A_{rms}

- If $ACV < 10 V_{\text{rms}}$ or $ACA < 10 A_{\text{rms}}$, *rdy* is displayed.
- If the fundamental frequency is outside the range 45–65Hz, *out.F* is displayed.

Table 7.7 Inrush current

Function	Range	Accuracy
ACA	99.99 A	$\pm(3\% + 0.3 \text{ A})$
	599.9 A	$\pm(3\% + 5 \text{ dgt})^*$

* For measured values $< 1000 \text{ dgt}$, add 5 dgt to the accuracy.

Overload protection: 1000 V_{rms} , 600 A_{rms} .

Accuracy is defined for sine waves, $ACA \geq 10 A_{\text{rms}}$, $f_{\text{req.}} 50/60 \text{ Hz}$. Integration time approx. 100 ms.

7 Technical specifications

Table 7.8 Active power: watts (DC/AC)

Function	Range 1	Accuracy
DCW	9.999 kW (10 V, 5 A min)	$\pm(3\% + 0.05 \text{ kW})$
	99.99 kW (10 V, 5 A min)	$\pm(3\% + 0.5 \text{ kW})$
	599.9 kW (10 V, 5 A min)	$\pm(3\% + 10 \text{ dgt})$
ACW	9.999 kW (10 V, 5 A min)	$\pm(3\% + 10 \text{ dgt})$
	99.99 kW (10 V, 5 A min)	
	599.9 kW (10 V, 5 A min)	

1. The range is determined by the V/A range (9.999 kW: 100 V, 100 A; 99.99 kW: 1000 V, 100 A, or 100 V, 600 A; 599.9 kW: 1000 V, 600 A).

Overload protection: 1000 V_{rms} , 600 A_{rms} .

Accuracy defined for:

- ACW:
 - Sine waves, $ACV \geq 10 V_{\text{rms}}$, $ACA \geq 5 A_{\text{rms}}$.
 - Frequency 50–60 Hz, PF = 1.00.
- DCW: $DCV \geq 10 \text{ V}$, $DCA \geq 5 \text{ A}$.

Table 7.9 Power factor

Function	Range	Accuracy
PF	-1.00 to 0.00 to +1.00	$\pm 3^\circ \pm 1 \text{ dgt}$

Overload protection: 1000 V_{rms} , 600 A_{rms} .

7 Technical specifications

Table 7.10 Resistance and continuity and diode

Function	Range	Accuracy
Resistance	999.9 Ω	$\pm(1.0\% + 5 \text{ dgt})$
	9.999 k Ω	$\pm(1.0\% + 3 \text{ dgt})$
	99.99 k Ω	
Continuity	999.9 Ω	$\pm(1.0\% + 5 \text{ dgt})$
Diode	0.40–0.80 V	$\pm 0.1V$

Overload protection: 1000 V_{rms}.

Maximum test current: Approx. 0.5 mA.

Maximum open circuit voltage for Ω : Approx. 2.4 V.

Maximum open circuit voltage for diode: Approx. ± 1.6 V.

Continuity threshold:

- < 30 Ω beep on.
- > 100 Ω beep off.

Continuity indicator: 2 kHz tone buzzer.

Continuity response time: <100 ms.

Table 7.11 Capacitance

Function	Range	Accuracy
Capacitance	3.999 μF	$\pm(1.9\% + 8 \text{ dgt})$
	39.99 μF	
	399.9 μF	
	3.999 mF	

Overload protection: 1000 V_{rms}.

8 Technical support for external meters

Website	http://www.flir.com/test
Technical support	TMSupport@flir.com
Repairs	Repair@flir.com
Phone number	+1 855-499-3662 (toll-free)

9 Warranties

9.1 FLIR Global Limited Lifetime Warranty

A qualifying FLIR Test and Measurement product (the "Product") purchased either directly from FLIR Commercial Systems Inc and affiliates (FLIR) or from an authorized FLIR distributor or reseller that Purchaser registers on-line with FLIR is eligible for coverage under FLIR's Limited Lifetime Warranty, subject to the terms and conditions in this document. This warranty only applies to purchases of Qualifying Products (see below) purchased and manufactured after April 1, 2013.

PLEASE READ THIS DOCUMENT CAREFULLY; IT CONTAINS IMPORTANT INFORMATION ABOUT THE PRODUCTS THAT QUALIFY FOR COVERAGE UNDER THE LIMITED LIFETIME WARRANTY, PURCHASER'S OBLIGATIONS, HOW TO ACTIVATE THE WARRANTY, WARRANTY COVERAGE, AND OTHER IMPORTANT TERMS, CONDITIONS, EXCLUSIONS AND DISCLAIMERS.

1. PRODUCT REGISTRATION. To qualify for FLIR's Limited Lifetime Warranty, Purchaser must fully register the Product directly with FLIR on-line at <http://www.flir.com> within Sixty (60) DAYS of the date the Product was purchased by the first retail customer (the "Purchase Date"). Qualifying PRODUCTS THAT ARE NOT REGISTERED ON-LINE WITHIN SIXTY (60) DAYS OF THE PURCHASE DATE WILL HAVE A LIMITED ONE YEAR WARRANTY FROM DATE OF PURCHASE.

2. QUALIFYING PRODUCTS. Upon registration, Test and Measurement products that qualify for coverage under FLIR's Limited Lifetime Warranty are: MR7x, CM7x, CM8x, DMxx, VP5x not including accessories which may have their own warranty.

3. WARRANTY PERIODS. For purposes of the The Limited Lifetime Warranty, Lifetime is defined as seven years (7) after the product is no longer manufactured, or ten years (10) from date of purchase, whichever is greater. This Warranty is only applicable to the original owner of the Products.

Any Product that is repaired or replaced under warranty is covered under this Limited Lifetime Warranty for one hundred eighty days (180) days from the date of return shipment by FLIR or for the remaining duration of the applicable Warranty Period, whichever is longer.

4. LIMITED WARRANTY. In accordance with the terms and conditions of this Limited Lifetime Warranty, and except as excluded or disclaimed in this document, FLIR warrants, from the Purchase Date, that all fully registered Products will conform to FLIR's published Product specifications and be free from defects in materials and workmanship during the applicable Warranty Period. PURCHASER'S SOLE AND EXCLUSIVE REMEDY UNDER THIS WARRANTY, AT FLIR'S SOLE DISCRETION, IS THE REPAIR OR REPLACEMENT OF

DEFECTIVE PRODUCTS IN A MANNER, AND BY A SERVICE CENTER, AUTHORIZED BY FLIR. IF THIS REMEDY IS ADJUDICATED TO BE INSUFFICIENT, FLIR SHALL REFUND PURCHASER'S PAID PURCHASE PRICE AND HAVE NO OTHER OBLIGATION OR LIABILITY TO BUYER WHATSOEVER.

5. WARRANTY EXCLUSIONS AND DISCLAIMERS. FLIR MAKES NO OTHER WARRANTY OF ANY KIND WITH RESPECT TO THE PRODUCTS. ALL OTHER WARRANTIES, EXPRESS OR IMPLIED, INCLUDING BUT NOT LIMITED TO IMPLIED WARRANTIES OF MERCHANTABILITY, FITNESS FOR A PARTICULAR PURPOSE (EVEN IF PURCHASER HAS NOTIFIED FLIR OF ITS INTENDED USE FOR THE PRODUCTS), AND NON-INFRINGEMENT ARE EXPRESSLY EXCLUDED FROM THIS AGREEMENT.

THIS WARRANTY EXPRESSLY EXCLUDES ROUTINE PRODUCT MAINTENANCE, SOFTWARE UPDATES, AND REPLACEMENT OF MANUALS, FUSES, OR DISPOSABLE BATTERIES. FLIR FURTHER EXPRESSLY DISCLAIMS ANY WARRANTY COVERAGE WHERE THE ALLEGED NONCONFORMITY IS DUE TO NORMAL WEAR AND TEAR, OTHER ALTERATION, MODIFICATION, REPAIR, ATTEMPTED REPAIR, IMPROPER USE, IMPROPER MAINTENANCE, NEGLIGENCE, ABUSE, IMPROPER STORAGE, FAILURE TO FOLLOW ANY PRODUCT INSTRUCTIONS, DAMAGE (WHETHER CAUSED BY ACCIDENT OR OTHERWISE), OR ANY OTHER IMPROPER CARE OR HANDLING OF THE PRODUCTS CAUSED BY ANYONE OTHER THAN FLIR OR FLIR'S EXPRESSLY AUTHORIZED DESIGNEE.

THIS DOCUMENT CONTAINS THE ENTIRE WARRANTY AGREEMENT BETWEEN PURCHASER AND FLIR AND SUPERSEDES ALL PRIOR WARRANTY NEGOTIATIONS, AGREEMENTS, PROMISES AND UNDERSTANDINGS BETWEEN PURCHASER AND FLIR. THIS WARRANTY MAY NOT BE ALTERED WITHOUT THE EXPRESS WRITTEN CONSENT OF FLIR.

6. WARRANTY RETURN, REPAIR AND REPLACEMENT. To be eligible for warranty repair or replacement, Purchaser must notify FLIR within thirty (30) days of discovering of any apparent defect in materials or workmanship. Before Purchaser may return a Product for warranty service or repair, Purchaser must first obtain a returned material authorization (RMA) number from FLIR. To obtain the RMA number Owner must provide an original proof of purchase. For additional information, to notify FLIR of an apparent defect in materials or workmanship, or to request an RMA number, visit <http://www.flir.com>. Purchaser is solely responsible for complying with all RMA instructions provided by FLIR including but not limited to adequately packaging the Product for shipment to FLIR and for all packaging and shipping costs. FLIR will pay for returning to Purchaser any Product that FLIR repairs or replaces under warranty.

9 Warranties

FLIR reserves the right to determine, in its sole discretion, whether a returned Product is covered under Warranty. If FLIR determines that any returned Product is not covered under Warranty or is otherwise excluded from Warranty coverage, FLIR may charge Purchaser a reasonable handling fee and return the Product to Purchaser, at Purchaser's expense, or offer Purchaser the option of handling the Product as a non-warranty return.

7. NON-WARRANTY RETURN. Purchaser may request that FLIR evaluate and service or repair a Product not covered under warranty, which FLIR may agree to do in its sole discretion. Before Purchaser returns a Product for non-warranty evaluation and repair, Purchaser must contact FLIR by visiting <http://www.flir.com> to request an evaluation and obtain an RMA. Purchaser is solely responsible for complying with all RMA instructions provided by FLIR including but not limited to adequately packaging the Product for shipment to FLIR and for all packaging and shipping costs. Upon receipt of an authorized non-warranty return, FLIR will evaluate the Product and contact Purchaser regarding the feasibility of and the costs and fees associated with Purchaser's request. Purchaser shall be responsible for the reasonable cost of FLIR's evaluation, for the cost of any repairs or services authorized by Purchaser, and for the cost of repackaging and returning the Product to Purchaser.

Any non-warranty repair of a Product is warranted for one hundred eighty days (180) days from the date of return shipment by FLIR to be free from defects in materials and workmanship only, subject to all of the limitations, exclusions and disclaimers in this document.

9.2 FLIR Test and Measurement Limited 2 Year Warranty

A qualifying FLIR Test and Measurement product (the "Product") purchased either directly from FLIR Commercial Systems Inc and affiliates (FLIR) or from an authorized FLIR distributor or reseller that Purchaser registers on-line with FLIR is eligible for coverage under FLIR's Limited Warranty, subject to the terms and conditions in this document. This warranty only applies to purchases of Qualifying Products (see below) purchased and manufactured after April 1, 2013.

PLEASE READ THIS DOCUMENT CAREFULLY; IT CONTAINS IMPORTANT INFORMATION ABOUT THE PRODUCTS THAT QUALIFY FOR COVERAGE UNDER THE LIMITED WARRANTY, PURCHASER'S OBLIGATIONS, HOW TO ACTIVATE THE WARRANTY, WARRANTY COVERAGE, AND OTHER IMPORTANT TERMS, CONDITIONS, EXCLUSIONS AND DISCLAIMERS.

1. PRODUCT REGISTRATION. To qualify for FLIR's Limited Warranty, Purchaser must fully register the Product directly with FLIR on-line at <http://www.flir.com> within Sixty (60) DAYS of the date the Product was purchased by the first retail customer (the "Purchase Date"). Qualifying PRODUCTS THAT ARE NOT REGISTERED ON-LINE

WITHIN SIXTY (60) DAYS OF THE PURCHASE DATE WILL HAVE A LIMITED ONE YEAR WARRANTY FROM DATE OF PURCHASE.

2. QUALIFYING PRODUCTS. Upon registration, Test and Measurement products that qualify for coverage under FLIR's Limited Warranty are: VS70 Videoscope, VSAxx Articulation Camera, VSCxx Camera, VSSxx Probe Spool, VST handset, MR02 Pin Extension Probe, and TAxX not including accessories which may have their own warranty.

3. WARRANTY PERIODS. The applicable Limited Warranty Period measured from the Purchase data are:

Products	Limited Warranty Period
VS70, VSAxx, VSCxx, VSSxx, VST, MR02, TAxX	TWO (2) Years

Any Product that is repaired or replaced under warranty is covered under this Limited Warranty for one hundred eighty days (180) days from the date of return shipment by FLIR or for the remaining duration of the applicable Warranty Period, whichever is longer.

4. LIMITED WARRANTY. In accordance with the terms and conditions of this Limited Warranty, and except as excluded or disclaimed in this document, FLIR warrants, from the Purchase Date, that all fully registered Products will conform to FLIR's published product specifications and be free from defects in materials and workmanship during the applicable Warranty Period. PURCHASER'S SOLE AND EXCLUSIVE REMEDY UNDER THIS WARRANTY, AT FLIR'S SOLE DISCRETION, IS THE REPAIR OR REPLACEMENT OF DEFECTIVE PRODUCTS IN A MANNER, AND BY A SERVICE CENTER, AUTHORIZED BY FLIR. IF THIS REMEDY IS ADJUDICATED TO BE INSUFFICIENT, FLIR SHALL REFUND PURCHASER'S PAID PURCHASE PRICE AND HAVE NO OTHER OBLIGATION OR LIABILITY TO BUYER WHATSOEVER.

5. WARRANTY EXCLUSIONS AND DISCLAIMERS. FLIR MAKES NO OTHER WARRANTY OF ANY KIND WITH RESPECT TO THE PRODUCTS. ALL OTHER WARRANTIES, EXPRESS OR IMPLIED, INCLUDING BUT NOT LIMITED TO IMPLIED WARRANTIES OF MERCHANTABILITY, FITNESS FOR A PARTICULAR PURPOSE (EVEN IF PURCHASER HAS NOTIFIED FLIR OF ITS INTENDED USE FOR THE PRODUCTS), AND NON-INFRINGEMENT ARE EXPRESSLY EXCLUDED FROM THIS AGREEMENT.

THIS WARRANTY EXPRESSLY EXCLUDES ROUTINE PRODUCT MAINTENANCE, SOFTWARE UPDATES, AND REPLACEMENT OF FUSES, OR DISPOSABLE BATTERIES. FLIR FURTHER EXPRESSLY DISCLAIMS ANY WARRANTY COVERAGE WHERE THE ALLEGED NONCONFORMITY IS DUE TO NORMAL WEAR AND TEAR, OTHER ALTERATION, MODIFICATION, REPAIR, ATTEMPTED REPAIR, IMPROPER USE, IMPROPER

9 Warranties

MAINTENANCE, NEGLIGENCE, ABUSE, IMPROPER STORAGE, FAILURE TO FOLLOW ANY PRODUCT INSTRUCTIONS, DAMAGE (WHETHER CAUSED BY ACCIDENT OR OTHERWISE), OR ANY OTHER IMPROPER CARE OR HANDLING OF THE PRODUCTS CAUSED BY ANYONE OTHER THAN FLIR OR FLIR'S EXPRESSLY AUTHORIZED DESIGNEE.

THIS DOCUMENT CONTAINS THE ENTIRE WARRANTY AGREEMENT BETWEEN PURCHASER AND FLIR AND SUPERSEDES ALL PRIOR WARRANTY NEGOTIATIONS, AGREEMENTS, PROMISES AND UNDERSTANDINGS BETWEEN PURCHASER AND FLIR. THIS WARRANTY MAY NOT BE ALTERED WITHOUT THE EXPRESS WRITTEN CONSENT OF FLIR.

6. WARRANTY RETURN, REPAIR AND REPLACEMENT. To be eligible for warranty repair or replacement, Purchaser must notify FLIR within thirty (30) days of discovering of any apparent defect in materials or workmanship. Before Purchaser may return a Product for warranty service or repair, Purchaser must first obtain a returned material authorization (RMA) number from FLIR. To obtain the RMA number Owner must provide an original proof of purchase. For additional information, to notify FLIR of an apparent defect in materials or workmanship, or to request an RMA number, visit <http://www.flir.com>. Purchaser is solely responsible for complying with all RMA instructions provided by FLIR including but not limited to adequately packaging the Product for shipment to FLIR and for all packaging and shipping costs. FLIR will pay for returning to Purchaser any Product that FLIR repairs or replaces under warranty.

FLIR reserves the right to determine, in its sole discretion, whether a returned Product is covered under Warranty. If FLIR determines that any returned Product is not covered under Warranty or is otherwise excluded from Warranty coverage, FLIR may charge Purchaser a reasonable handling fee and return the Product to Purchaser, at Purchaser's expense, or offer Purchaser the option of handling the Product as a non-warranty return.

7. NON-WARRANTY RETURN. Purchaser may request that FLIR evaluate and service or repair a Product not covered under warranty, which FLIR may agree to do in its sole discretion. Before Purchaser returns a Product for non-warranty evaluation and repair, Purchaser must contact FLIR by visiting <http://www.flir.com> to request an evaluation and obtain an RMA. Purchaser is solely responsible for complying with all RMA instructions provided by FLIR including but not limited to adequately packaging the Product for shipment to FLIR and for all packaging and shipping costs. Upon receipt of an authorized non-warranty return, FLIR will evaluate the Product and contact Purchaser regarding the feasibility of and the costs and fees associated with Purchaser's request. Purchaser shall be responsible for the reasonable cost of FLIR's evaluation, for the cost of any repairs or services authorized by Purchaser, and for the cost of repackaging and returning the Product to Purchaser.

Any non-warranty repair of a Product is warranted for one hundred eighty days (180) days from the date of return shipment by FLIR to be free from defects in materials and workmanship only, subject to all of the limitations, exclusions and disclaimers in this document.

A note on the technical production of this publication

This publication was produced using XML — the eXtensible Markup Language. For more information about XML, please visit <http://www.w3.org/XML/>

A note on the typeface used in this publication

This publication was typeset using Linotype Helvetica™ World. Helvetica™ was designed by Max Miedinger (1910–1980)

LOEF (List Of Effective Files)

T501025.xml; en-US; AI; 33557; 2016-02-18



Website

<http://www.flir.com>

Customer support

<http://support.flir.com>

Copyright

© 2016, FLIR Systems, Inc. All rights reserved worldwide.

Disclaimer

Specifications subject to change without further notice. Models and accessories subject to regional market considerations. License procedures may apply. Products described herein may be subject to US Export Regulations. Please refer to exportquestions@flir.com with any questions.

Publ. No.: T559825
Release: AI
Commit: 33557
Head: 33557
Language: en-US
Modified: 2016-02-18
Formatted: 2016-02-18



T559825